

HAM-LET PRECISION  
INSTRUMENT PIPE FITTINGS

**PIPELINE**

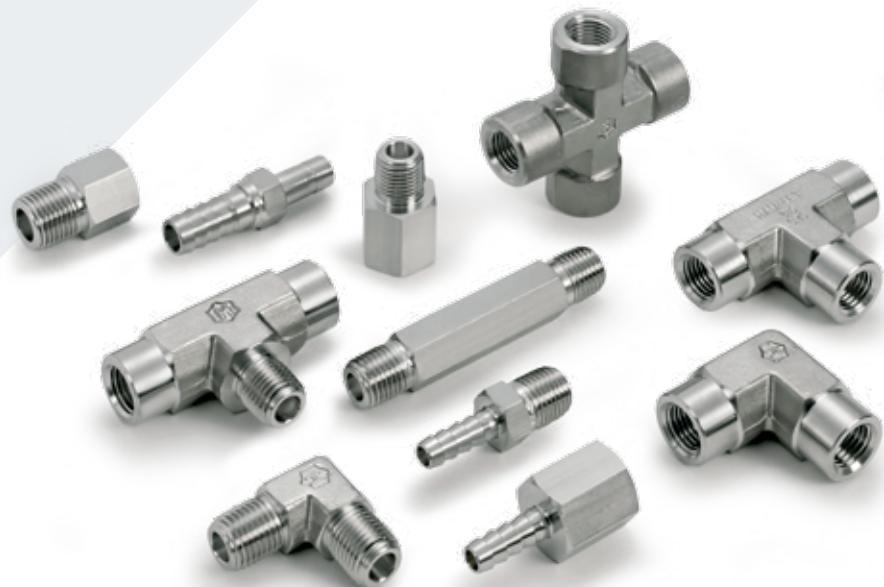
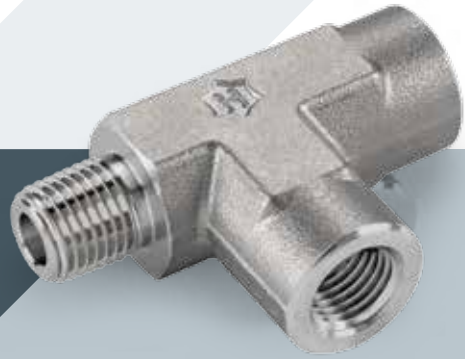

**GENERAL**

The HAM-LET Pipeline range of connectors is manufactured for typical applications in chemical and petrochemical processing plants, as well as oil, gas and power generation industries.

**FEATURE**

- Sizes range from 1/16" to 2".
- Fittings are properly packaged with the exposed threads protected to ensure they are not damaged during delivery.
- All pipe threads meet the requirements of **ASME/ANSI B1.20.1** (1983) for tapered pipe threads (NPT).
- Working pressures are calculated in accordance with Power Piping Code **ANSI B 31.1**, Refiner Piping Code **ASME/ANSI B 31.3** and section VIII of **ASME** Boiler & Pressure Vessel Code.

**PRESSURE RATINGS (PSI)**

NPT or BSPT/ISO size	STAINLESS STEEL 316		BRASS	
	male	female	male	female
1/16	11000	6700	5500	3300
1/8	10000	6500	5000	3200
1/4	8000	6600	4000	3300
3/8	7800	5300	3900	2600
1/2	7700	4900	3800	2400
3/4	7300	4600	3600	2300
1	5300	4400	2600	2200
1 1/4	6000	5000	3000	2500
1 1/2	5000	4600	2500	2300
2	3900	3900	1900	1900

**MATERIALS**

MATERIAL	Specifications	
	Barstock	Forgings
STAINLESS STEEL 316	ASTM A-276	ASTM A-182
	ASTM A-479	
BRASS	ASTM B-453	ASME B-283
	ASTM B-16	
	DIN 176.60	

**INSTALLATION INSTRUCTIONS**

To ensure a leak-tight seal, HAM-LET recommends the use of a pipe thread sealant on all NPT threads. The most effective sealing method is PTFE tape. Tape should be used only on male tapered pipe threads.

Do not use tape on flared, coned or tube fitting ends!

Clean both male and female tapered threads. Wrap tape in the direction of the male tapered thread spiral.

**Note:** Two wraps are suggested for stainless steel tapered pipe threads. Make sure tape does not overhang the first thread, as the tape might shred and enter the fluid system. Cut off excess tape. The connection is now ready for proper makeup.

**ORDERING INFORMATION**

EXAMPLE:

**120H****Material Description****SS** - Stainless Steel 316**B** - Brass**1/2**





x

**1/4**

All orders should include ordering information and material description.

# PIPELINE INDEX

<b>ELBOW</b> 100H	104	
<b>MALE ELBOW</b> 100HM	104	
<b>TEE</b> 101H	104	
<b>MALE TEE</b> 101HM	105	
<b>CROSS</b> 102H	105	
<b>HEX COUPLING</b> 103H	105	
<b>UNION RECORD</b> 104H	106	
<b>HOLLOW HEX PLUGS</b> 107H	106	
<b>HOLLOW HEX PLUGS</b> SAE/MS STRAIGHT THREAD BOSS 107HOB	106	
<b>PIPE CAP</b> 108H	107	
<b>REDUCING BUSHING</b> 110H	107	

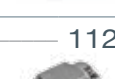
<b>REDUCING BUSHING</b> SAE/MS STRAIGHT THREAD BOSS 110HOB	108	
<b>HEX LONG NIPPLE</b> 113H	108	
<b>STREET ELBOW</b> 116H	109	
<b>HEX REDUCING COUPLING</b> 119H	109	
<b>ADAPTER NPT</b> 120H	110	
<b>ADAPTER</b> NPT FEMALE TO MALE BSPT 120HNR	110	
<b>ADAPTER</b> FEMALE NPT TO MALE BSPP 120HNG	111	
<b>ADAPTER</b> NPT TO SAE/MS STRAIGHT THREAD BOSS 120HNOB	111	
<b>ADAPTER</b> FEMALE BSPT TO MALE NPT 120HRN	111	
<b>GAUGE ADAPTER</b> FEMALE BSPP TO MALE NPT 120HGN	112	
<b>PIPE PLUG NPT</b> 121H	112	
<b>HEX HEAD PLUG</b> SAE/MS STRAIGHT THREAD BOSS 121HOB	112	

<b>HEX NIPPLE</b> 122H	113	
<b>HEX NIPPLE</b> MALE NPT TO MALE BSPT 122HNR	113	
<b>HEX NIPPLE</b> MALE NPT TO MALE BSPP 122HNG	114	
<b>HEX NIPPLE</b> NPT TO SAE/MS STRAIGHT BOSS 122HNOB	114	
<b>CLOSE NIPPLE</b> 122HCN	114	
<b>REDUCING NIPPLE</b> 123H	115	
<b>BRANCH TEE</b> 3600H	115	
<b>STREET TEE</b> 3750H	116	
<b>MALE HOSE CONNECTOR</b> 130HM	116	
<b>FEMALE HOSE CONNECTOR</b> 130HF	117	
<b>TUBE TO HOSE CONNECTOR</b> 130LT	117	

## 100 H ELBOW

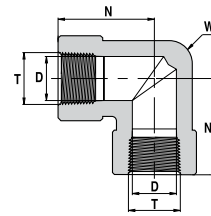

Ordering Information	T Female NPT size	N		D Min. Opening		W Wrench Flat
		inch	mm	inch	mm	inch
100H _ 1/8	1/8	1.04	26.4	0.31	7.8	5/8
100H _ 1/4	1/4	1.17	29.7	0.41	10.5	11/16
100H _ 3/8	3/8	1.42	36.1	0.56	14.2	15/16
100H _ 1/2	1/2	1.56	39.6	0.69	17.4	1 1/8
100H _ 3/4	3/4	1.92	48.8	0.90	22.9	1 3/8
100H _ 1	1	1.91	48.5	1.13	28.7	1 11/16

## 100 HM MALE ELBOW

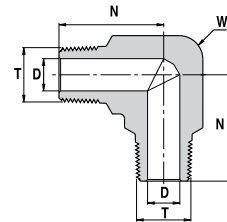

Ordering Information	T Male NPT Size	N		D Min. Opening		W Wrench Flat
		inch	mm	inch	mm	inch
100HM _ 1/8	1/8	0.88	22.4	0.19	4.8	1/2
100HM _ 1/4	1/4	1.05	26.7	0.28	7.1	5/8
100HM _ 3/8	3/8	1.17	29.7	0.38	9.6	13/16
100HM _ 1/2	1/2	1.45	36.8	0.47	11.9	15/16

## 101 H TEE

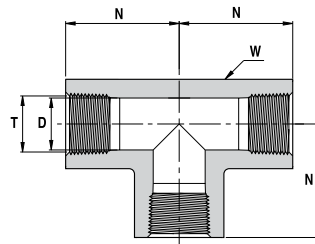

Ordering Information	A Female NPT Size	N		D Min. Opening		W Wrench Flat
		inch	mm	inch	mm	inch
101H _ 1/8	1/8	1.04	26.4	0.31	7.8	5/8
101H _ 1/4	1/4	1.17	29.7	0.41	10.5	13/16
101H _ 3/8	3/8	1.42	36.1	0.56	14.2	15/16
101H _ 1/2	1/2	1.56	39.6	0.69	17.4	1 1/8
101H _ 3/4	3/4	1.92	48.8	0.90	22.9	1 3/8
101H _ 1	1	1.91	48.5	1.13	28.7	1 11/16

"D" Dimension is minimum opening. Dimensions are for reference only, and are subject to change without notice.

## 101 HM MALE TEE

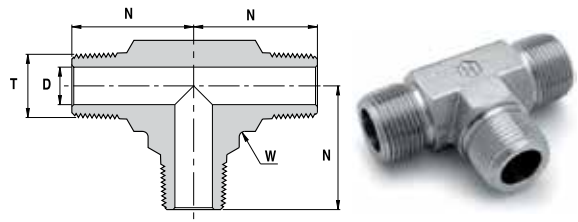

Ordering Information	T Male NPT Size	N		D Min. Opening		W Wrench Flat
		inch	mm	inch	mm	inch
		101HM _ 1/8	1/8	0.88	22.4	0.19
101HM _ 1/4	1/4	1.05	26.7	0.28	7.1	5/8
101HM _ 3/8	3/8	1.17	29.7	0.38	9.6	13/16
101HM _ 1/2	1/2	1.45	36.8	0.47	11.9	15/16

## 102 H CROSS

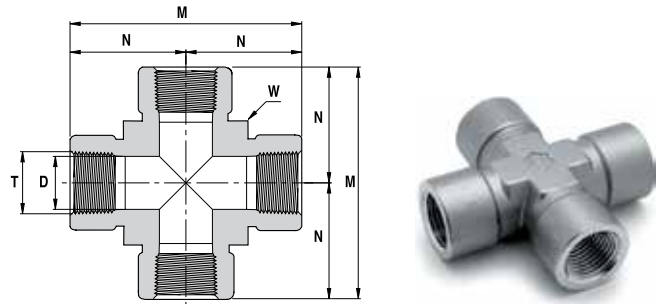

Ordering Information	T Female NPT Size	N		M		D Min. Opening		W Wrench Flat
		inch	mm	inch	mm	inch	mm	inch
		102H _ 1/8	1/8	1.04	26.4	2.08	52.8	0.31
102H _ 1/4	1/4	1.17	29.7	2.34	59.4	0.41	10.5	11/16
102H _ 3/8	3/8	1.42	36.1	2.84	72.2	0.56	14.2	13/16
102H _ 1/2	1/2	1.56	39.6	3.12	79.2	0.69	17.4	1
102H _ 3/4	3/4	1.92	48.8	3.84	97.6	0.90	22.9	1 1/4
102H _ 1	1	1.91	48.5	3.82	97.0	1.13	28.7	1 11/16

## 103 H HEX COUPLING

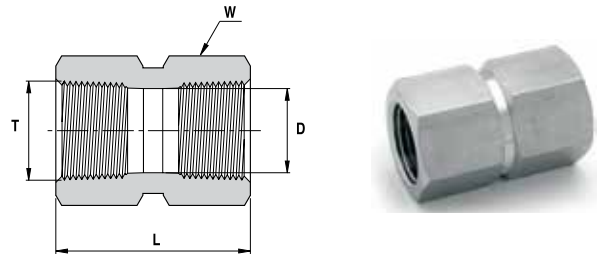

Ordering Information	T Female NPT Size	L		D Min. Opening		W Hex. Flat
		inch	mm	inch	mm	inch
		103H _ 1/8	1/8	0.81	20.6	0.31
103H _ 1/4	1/4	1.19	30.2	0.41	10.5	3/4
103H _ 3/8	3/8	1.31	33.3	0.56	14.2	7/8
103H _ 1/2	1/2	1.56	39.6	0.69	17.4	1 1/16
103H _ 3/4	3/4	1.62	41.1	0.90	22.9	1 5/16
103H _ 1	1	2.00	50.8	1.13	28.7	1 5/8

“D” Dimension is minimum opening. Dimensions are for reference only, and are subject to change without notice.

## 104 H UNION RECORD

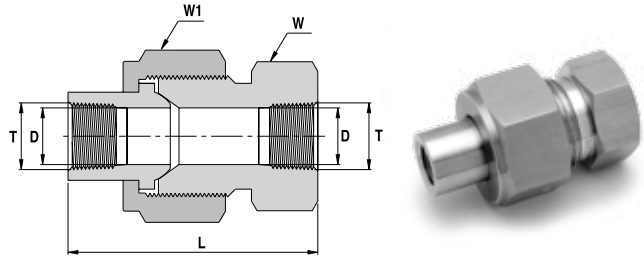

Ordering Information	T Female NPT Size	L		D Min. Opening		W Hex. Flat		W1 Hex. Flat
		inch	mm	inch	mm	inch	mm	
104H _ 1/8	1/8	1.81	46.0	0.27	6.9	15/16	23.81	1 1/8
104H _ 1/4	1/4	2.34	59.4	0.36	9.1	1 3/16	30.16	1 3/8
104H _ 3/8	3/8	2.50	63.5	0.52	13.2	1 5/16	33.34	1 1/2
104H _ 1/2	1/2	2.69	68.3	0.62	15.7	1 5/8	41.28	1 3/4
104H _ 3/4	3/4	3.12	79.2	0.87	22.1	1 7/8	47.63	2
104H _ 1	1	3.56	90.4	1.03	26.2	2 3/8	60.33	2 1/2

## 107 H HOLLOW HEX PLUGS

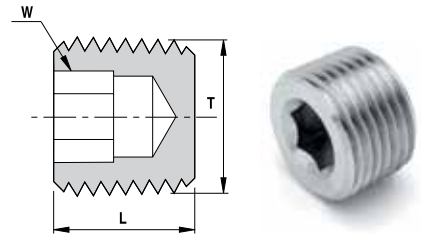

Ordering Information	T Male NPT Size	L		W Hex. Flat
		inch	mm	inch
107H _ 1/8	1/8	0.29	7.4	3/16
107H _ 1/4	1/4	0.44	11.3	1/4
107H _ 3/8	3/8	0.44	11.3	5/16
107H _ 1/2	1/2	0.61	15.5	3/8

## 107HOB HOLLOW HEX PLUG SAE/MS STRAIGHT THREAD BOSS \*

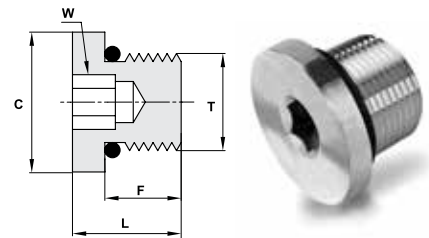

Ordering Information	T Straight Thread UN	L		F		C		W Hex. Flat	O-Ring**
		inch	mm	inch	mm	inch	mm		
107HOB _ 7/16-20	7/16-20	0.45	11.4	0.36	9.1	0.56	14.2	3/16	-904
107HOB _ 1/2-20	1/2-20	0.45	11.4	0.36	9.1	0.63	15.9	3/16	-905
107HOB _ 9/16-18	9/16-18	0.48	12.2	0.39	9.9	0.69	17.5	1/4	-906
107HOB _ 3/4-16	3/4-16	0.56	14.2	0.44	11.2	0.88	22.4	5/16	-908

\* Per SAE J1926 and MS 16142. See page 80 for mounting dimensions.

\*\* O-rings used are Fluorocarbon FKM 90 Durometer. Other O-ring materials are available on request.

## 108 H PIPE CAP

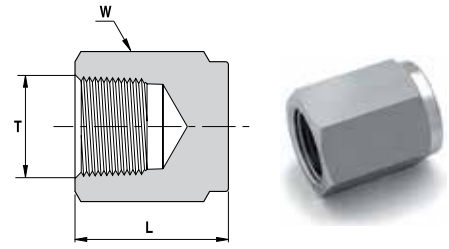

Ordering Information	T Female NPT Size	L		W Hex. Flat
		inch	mm	inch
108H_ 1/8	1/8	0.75	19.1	9/16
108H_ 1/4	1/4	0.91	23.1	3/4
108H_ 3/8	3/8	1.03	26.2	7/8
108H_ 1/2	1/2	1.34	34.0	1 1/16
108H_ 3/4	3/4	1.44	36.6	1 5/16
108H_ 1	1	1.62	41.1	1 5/8

## 110 H REDUCING BUSHING

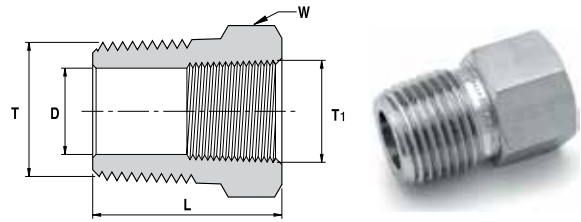

Ordering Information	T Male NPT Size	T1 Female NPT Size	L		D Min. Opening		W Hex. Flat
			inch	mm	inch	mm	inch
110H_ 1/8 X 1/16	1/8	1/16	1.03	26.2	0.19	4.8	7/16
110H_ 1/4 X 1/8	1/4	1/8	1.06	26.9	0.28	7.1	9/16
110H_ 3/8 X 1/8	3/8	1/8	0.86	21.8	0.34	8.6	11/16
110H_ 3/8 X 1/4	3/8	1/4	1.19	30.2	0.38	9.6	3/4
110H_ 1/2 X 1/8	1/2	1/8	1.08	27.4	0.34	8.6	7/8
110H_ 1/2 X 1/4	1/2	1/4	1.08	27.4	0.41	10.5	7/8
110H_ 1/2 X 3/8	1/2	3/8	1.41	35.8	0.47	11.9	7/8
110H_ 3/4 X 1/4	3/4	1/4	1.08	27.4	0.45	11.4	1 1/16
110H_ 3/4 X 3/8	3/4	3/8	1.08	27.4	0.56	14.2	1 1/16
110H_ 3/4 X 1/2	3/4	1/2	1.63	41.4	0.62	15.7	1 1/16
110H_ 1 X 1/4	1	1/4	1.37	34.8	0.41	10.5	1 3/8
110H_ 1 X 3/8	1	3/8	1.37	34.8	0.56	14.2	1 3/8
110H_ 1 X 1/2	1	1/2	1.37	34.8	0.69	17.4	1 3/8
110H_ 1 X 3/4	1	3/4	1.85	47.0	0.87	22.1	1 3/8
110H_ 1 1/4 X 1/2	1 1/4	1/2	1.46	37.1	0.69	17.4	1 3/4
110H_ 1 1/4 X 3/4	1 1/4	3/4	1.47	37.3	0.90	22.9	1 3/4
110H_ 1 1/4 X 1	1 1/4	1	1.94	49.3	1.09	27.8	1 3/4
110H_ 1 1/2 X 1/2	1 1/2	1/2	1.61	40.9	0.72	18.3	2 1/8
110H_ 1 1/2 X 3/4	1 1/2	3/4	1.61	40.9	0.90	22.9	2 1/8
110H_ 1 1/2 X 1	1 1/2	1	1.61	40.9	1.17	29.7	2 1/8
110H_ 1 1/2 X 1 1/4	1 1/2	1 1/4	2.31	58.7	1.50	38.1	2 1/8
110H_ 2 X 1/2	2	1/2	1.83	46.5	0.73	18.5	2 3/4
110H_ 2 X 3/4	2	3/4	1.83	46.5	0.94	23.9	2 3/4
110H_ 2 X 1	2	1	1.83	46.5	1.17	29.7	2 3/4
110H_ 2 X 1 1/4	2	1 1/4	1.83	46.5	1.50	38.1	2 3/4
110H_ 2 X 1 1/2	2	1 1/2	1.83	46.5	1.73	43.9	2 3/4

"D" Dimension is minimum opening. Dimensions are for reference only, and are subject to change without notice.

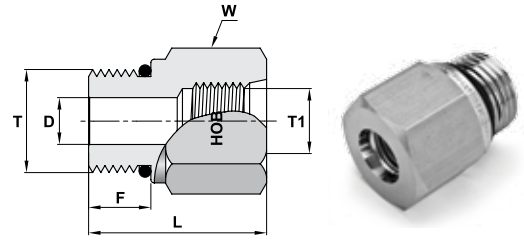
**110HOB****REDUCING BUSHING SAE/MS  
STRAIGHT THREAD BOSS \***

Ordering Information	T Straight Thread UN	T1 Straight Thread UN	D		L		F		W Hex. Flat inch	O-Ring**
			inch	mm	inch	mm	inch	mm		
110HOB _ 9/16-18 X 7/16-20	9/16-18	7/16-20	0.28	7.1	1.12	28.4	0.36	9.1	13/16	-906
110HOB _ 3/4-16 X 7/16-20	3/4-16	7/16-20	0.24	6.0	1.30	33.0	0.44	11.2	15/16	-908
110HOB _ 3/4-16 X 9/16-18	3/4-16	9/16-18	0.42	10.7	1.19	30.2	0.44	11.2	1	-908
110HOB _ 3/4-16 X 7/8-14	3/4-16	7/8-14	0.42	10.7	1.60	40.6	0.44	11.2	1 1/2	-908
110HOB _ 7/8-14 X 9/16-18	7/8-14	9/16-18	0.50	12.7	1.10	27.9	0.50	12.7	1	-910
110HOB _ 7/8-14 X 3/4-16	7/8-14	3/4-16	0.50	12.7	1.42	36.1	0.50	12.7	1 3/16	-910
110HOB _ 1 1/16-12 X 3/4-16	1 1/16-12	3/4-16	0.65	16.5	1.27	32.3	0.59	15.0	1 1/4	-912
110HOB _ 1 5/16-12 X 1 1/16-12	1 5/16-12	1 1/16-12	0.87	22.1	1.61	40.9	0.59	15.0	1 5/8	-916
110HOB _ 1 5/8-12 X 1 5/16-12	1 5/8-12	1 5/16-12	1.09	27.7	1.98	50.3	0.59	15.0	2 1/8	-920
110HOB _ 1 7/8-12 X 1 5/16-12	1 7/8-12	1 5/16-12	1.23	31.2	1.27	32.3	0.59	15.0	2 1/8	-924

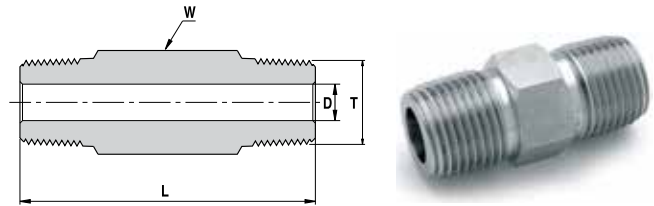
**113 H****HEX LONG NIPPLE**

Ordering Information	T Male NPT Size	L Available Lengths (inch)						D Min. Opening		W Hex. Flat inch
		1.50	2.00	2.50	3.00	4.00	6.00	inch	mm	
113H _ 1/8 X 1.5 / 2 / 2.5 / 3	1/8	✓	✓	✓	✓	-	-	0.19	4.8	7/16
113H _ 1/4 X 1.5 / 2 / 2.5 / 3 / 4	1/4	✓	✓	✓	✓	✓	-	0.28	7.1	9/16
113H _ 3/8 X 1.5 / 2 / 2.5 / 3 / 4	3/8	✓	✓	✓	✓	✓	-	0.38	9.6	11/16
113H _ 1/2 X 2 / 3 / 4	1/2	-	✓	-	✓	✓	✓	0.47	11.9	7/8
113H _ 3/4 X 2 / 3 / 4	3/4	-	✓	-	✓	✓	-	0.62	15.8	1 1/16
113H _ 1 X 3 / 4	1	-	-	-	✓	✓	-	0.88	22.4	1 3/8

\* Per SAE J1926 and MS 16142. See page 80 for mounting dimensions.

\*\* O-rings used are Fluorocarbon FKM 90 Durometer. Other O-ring materials are available on request.

"D" Dimension is minimum opening. Dimensions are for reference only, and are subject to change without notice.



## 116 H STREET ELBOW

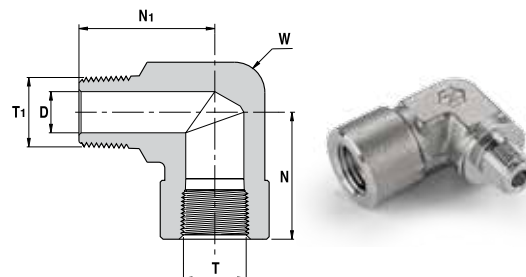

Ordering Information	T Female NPT Size	T1 Male NPT Size	N		N1		D Min. Opening		W Wrench Flat
			inch	mm	inch	mm	inch	mm	inch
			116H _ 1/16 X 1/16	1/16	1/16	0.86	21.8	0.88	22.4
116H _ 1/8 X 1/16	1/8	1/16	1.04	26.4	0.87	22.1	0.12	3.10	5/8
116H _ 1/8 X 1/8	1/8	1/8	1.04	26.4	0.87	22.1	0.19	4.80	5/8
116H _ 1/4 X 1/8	1/4	1/8	1.17	29.7	1.00	25.4	0.19	4.80	11/16
116H _ 1/4 X 1/4	1/4	1/4	1.17	29.7	1.17	29.7	0.28	7.10	11/16
116H _ 3/8 X 1/4	3/8	1/4	1.42	36.1	1.26	32.0	0.28	7.10	15/16
116H _ 3/8 X 3/8	3/8	3/8	1.42	36.1	1.26	32.0	0.38	9.60	15/16
116H _ 1/2 X 1/4	1/2	1/4	1.56	39.6	1.38	35.1	0.28	7.10	1 1/8
116H _ 1/2 X 3/8	1/2	3/8	1.56	39.6	1.38	35.1	0.38	9.60	1 1/8
116H _ 1/2 X 1/2	1/2	1/2	1.56	39.6	1.56	39.6	0.47	11.9	1 1/8
116H _ 3/4 X 3/4	3/4	3/4	1.92	48.8	1.67	42.4	0.62	15.8	1 3/8
116H _ 1 X 1	1	1	1.83	46.5	1.94	49.3	0.86	21.8	1 11/16

## 119 H HEX REDUCING COUPLING

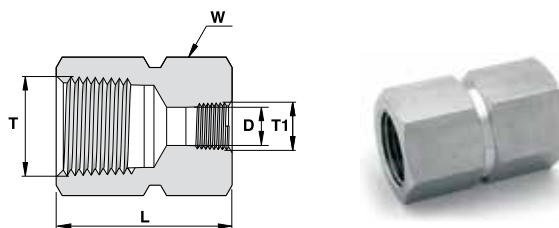

Ordering Information	T Female NPT Size	T1 Female NPT Size	L		D Min. Opening		W Hex. Flat
			inch	mm	inch	mm	inch
			119H _ 1/4 X 1/8	1/4	1/8	1.22	31.0
119H _ 3/8 X 1/4	3/8	1/4	1.38	35.1	0.41	10.5	7/8
119H _ 1/2 X 1/8	1/2	1/8	1.56	39.6	0.31	7.8	1 1/16
119H _ 1/2 X 1/4	1/2	1/4	1.75	44.5	0.41	10.5	1 1/16
119H _ 1/2 X 3/8	1/2	3/8	1.78	45.2	0.56	14.2	1 1/16
119H _ 3/4 X 1/4	3/4	1/4	1.81	46.0	0.41	10.5	1 5/16
119H _ 3/4 X 1/2	3/4	1/2	2.06	52.3	0.69	17.4	1 5/16
119H _ 1 X 1/2	1	1/2	2.19	55.6	0.69	17.4	1 5/8
119H _ 1 X 3/4	1	3/4	2.25	57.2	0.90	22.9	1 5/8

"D" Dimension is minimum opening. Dimensions are for reference only, and are subject to change without notice.

## 120 H ADAPTER NPT

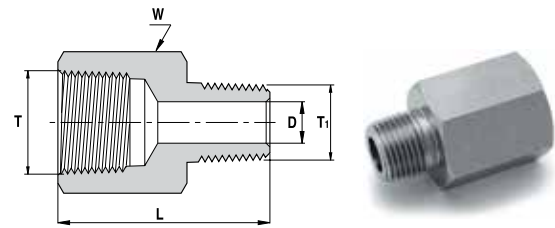

Ordering Information	T Female NPT Size	T1 Male NPT Size	L		D Min. Opening		W Hex. Flat inch
			inch	mm	inch	mm	
120H _ 1/8 X 1/16	1/8	1/16	1.09	27.7	0.12	3.0	9/16
120H _ 1/8 X 1/8	1/8	1/8	1.10	27.9	0.19	4.8	9/16
120H _ 1/4 X 1/8	1/4	1/8	1.26	32.0	0.19	4.8	3/4
120H _ 1/4 X 1/4	1/4	1/4	1.40	35.6	0.28	7.1	3/4
120H _ 3/8 X 1/8	3/8	1/8	1.33	33.8	0.19	4.8	7/8
120H _ 3/8 X 1/4	3/8	1/4	1.50	38.1	0.28	7.1	7/8
120H _ 3/8 X 3/8	3/8	3/8	1.51	38.4	0.38	9.6	7/8
120H _ 1/2 X 1/8	1/2	1/8	1.58	40.1	0.19	4.8	1 1/16
120H _ 1/2 X 1/4	1/2	1/4	1.76	44.7	0.28	7.1	1 1/16
120H _ 1/2 X 3/8	1/2	3/8	1.75	44.5	0.37	9.5	1 1/16
120H _ 1/2 X 1/2	1/2	1/2	1.94	49.3	0.47	11.9	1 1/16
120H _ 3/4 X 1/4	3/4	1/4	1.85	47.0	0.28	7.1	1 5/16
120H _ 3/4 X 3/8	3/4	3/8	1.82	46.2	0.37	9.5	1 5/16
120H _ 3/4 X 1/2	3/4	1/2	2.02	51.3	0.47	11.9	1 5/16
120H _ 3/4 X 3/4	3/4	3/4	2.02	51.3	0.62	15.8	1 5/16
120H _ 1 X 1/4	1	1/4	1.96	49.8	0.28	7.1	1 5/8
120H _ 1 X 1/2	1	1/2	2.16	54.9	0.47	11.9	1 5/8
120H _ 1 X 3/4	1	3/4	2.17	55.1	0.62	15.7	1 5/8
120H _ 1 X 1	1	1	2.28	57.9	0.86	21.8	1 5/8

## 120 HNR ADAPTER NPT TO BSPT

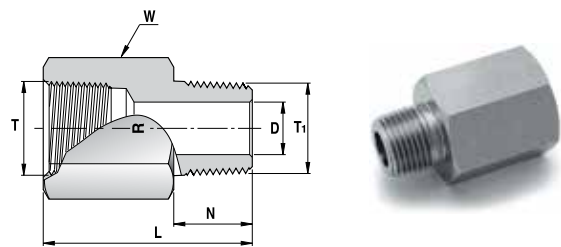

Ordering Information	T Female NPT Size	T1 Male BSPT ISO 7/1, BS21 Size	L		N		D Min. Opening		W Hex. Flat inch
			inch	mm	inch	mm	inch	mm	
120HNR _ 1/8	1/8	1/8-28	1.09	27.7	0.38	9.7	0.19	4.8	9/16
120HNR _ 1/4	1/4	1/4-19	1.42	36.1	0.56	14.2	0.28	7.1	3/4
120HNR _ 3/8	3/8	3/8-19	1.50	38.1	0.56	14.2	0.38	9.6	7/8
120HNR _ 1/2	1/2	1/2-14	1.94	49.3	0.75	19.0	0.47	11.9	1 1/16
120HNR _ 3/4	3/4	3/4-14	2.02	51.3	0.75	19.0	0.62	15.8	1 5/16
120HNR _ 1	1	1-11	2.30	58.4	0.94	23.9	0.88	22.4	1 5/8

“D” Dimension is minimum opening. Dimensions are for reference only, and are subject to change without notice.

## 120 HNG ADAPTER NPT TO BSPP

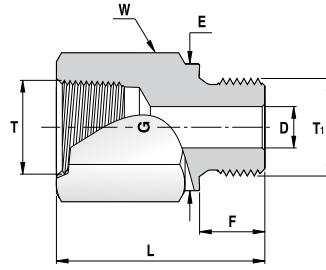

Ordering Information	T	T1	L		F		E		D		W
	Female NPT Size	Male BSPP ISO 228/1, BS 2779	inch	mm	inch	mm	inch	mm	inch	mm	Hex. Flat inch
120HNG _ 1/8	1/8	1/8-28	0.99	25.1	0.28	7.1	0.54	13.8	0.16	4.1	9/16
120HNG _ 1/4	1/4	1/4-19	1.32	33.5	0.44	11.2	0.70	18.0	0.23	5.8	3/4
120HNG _ 3/8	3/8	3/8-19	1.41	35.8	0.44	11.2	0.85	21.8	0.31	7.9	7/8
120HNG _ 1/2	1/2	1/2-14	1.74	44.2	0.56	14.2	1.02	26.0	0.47	11.9	1 1/16
120HNG _ 3/4	3/4	3/4-14	1.89	48.0	0.62	15.7	1.26	32.0	0.62	15.7	1 5/16
120HNG _ 1	1	1-11	2.10	53.3	0.72	18.3	1.53	39.0	0.78	19.8	1 5/8

For Parallel Threads Sealing, see page 76

## 120HNOB ADAPTER NPT TO SAE/MS STRAIGHT THREAD BOSS \*

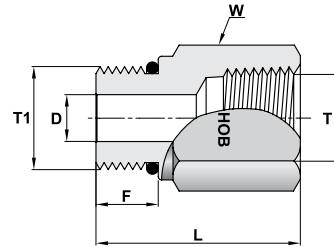

Ordering Information	T	T1	D		L		F		W	O-Ring**
	Female NPT Size	Straight Thread UN	inch	mm	inch	mm	inch	mm	Hex. Flat inch	
120HNOB _ 1/4 X 7/16-20	1/4	7/16-20	0.20	5.1	1.32	33.5	0.36	9.1	3/4	-904
120HNOB _ 3/8 X 9/16-18	3/8	9/16-18	0.28	7.1	1.39	35.3	0.39	9.9	15/16	-906
120HNOB _ 1/2 X 3/4-16	1/2	3/4-16	0.42	10.7	1.76	44.7	0.44	11.2	1 1/16	-908
120HNOB _ 3/4 X 1 1/16-12	3/4	1 1/16-12	0.66	16.7	1.99	50.5	0.59	15.0	1 3/8	-912
120HNOB _ 1 X 1 5/16-12	1	1 5/16-12	0.88	22.3	2.12	53.8	0.59	15.0	1 5/8	-916

## 120 HRN ADAPTER BSPT TO NPT

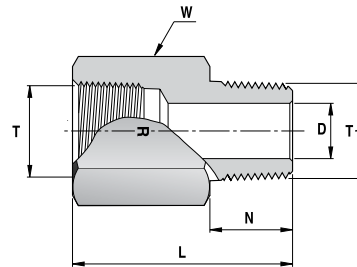

Ordering Information	T	T1	L		N		D		W
	Female BSPT ISO 7/1, BS21	Male NPT size	inch	mm	inch	mm	inch	mm	Hex. Flat inch
120HRN _ 1/4	1/4-19	1/4	1.43	36.3	0.56	14.2	0.28	7.1	3/4
120HRN _ 3/8	3/8-19	3/8	1.51	38.4	0.56	14.2	0.38	9.6	7/8
120HRN _ 1/2	1/2-14	1/2	1.96	49.8	0.75	19.1	0.47	11.9	1 1/16

\* Per SAE J1926 and MS 16142. See page 80 for mounting dimensions.

\*\* O-rings used are Fluorocarbon FKM 90 Durometer. Other O-ring materials are available on request.

"D" Dimension is minimum opening. Dimensions are for reference only, and are subject to change without notice.

## 120 HGN GAUGE ADAPTER BSPP TO NPT

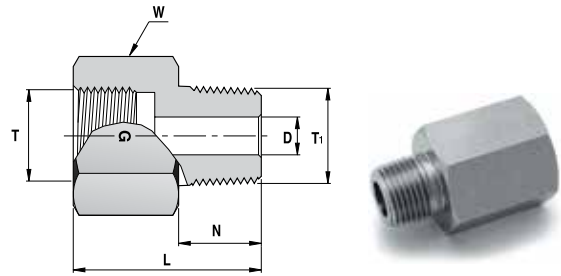

Ordering Information	T Female BSPP ISO 228/1, BS 2779 Size	T1 Male NPT Size	L		N		D Min. Opening		W Hex. Flat
			inch	mm	inch	mm	inch	mm	inch
120HGN _ 1/4	1/4-19	1/4	1.19	30.2	0.56	14.2	0.22	5.6	3/4
120HGN _ 3/8	3/8-19	3/8	1.27	32.3	0.56	14.2	0.26	6.6	15/16
120HGN _ 1/2	1/2-14	1/2	1.65	41.9	0.75	19.0	0.28	7.1	1 1/16

For Parallel Threads Sealing, see page 76

## 121 H PIPE PLUG NPT

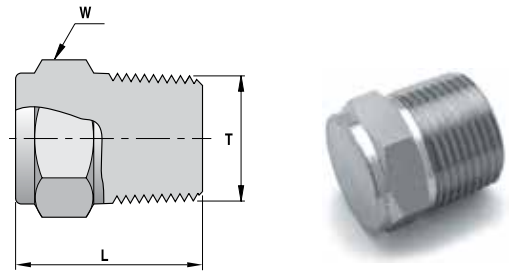

Ordering Information	T Male NPT Size	L		W Hex. Flat
		inch	mm	inch
121H _ 1/16	1/16	0.75	19.0	5/16
121H _ 1/8	1/8	0.75	19.0	7/16
121H _ 1/4	1/4	0.96	24.4	9/16
121H _ 3/8	3/8	0.99	25.2	11/16
121H _ 1/2	1/2	1.21	30.7	7/8
121H _ 3/4	3/4	1.21	30.7	1 1/16
121H _ 1	1	1.50	38.1	1 3/8

## 121HOB HEX HEAD PLUG SAE/MS STRAIGHT THREAD BOSS\*

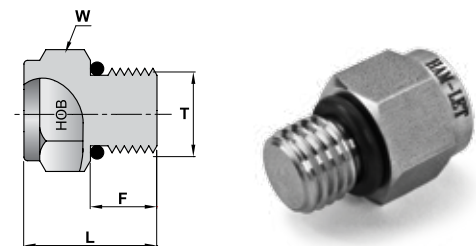

Ordering Information	T Straight Thread UN	L		F		W Hex. Flat	O-Ring**
		inch	mm	inch	mm	inch	
121HOB _ 5/16-24	5/16-24	0.70	17.8	0.30	7.6	7/16	-902
121HOB _ 7/16-20	7/16-20	0.76	19.3	0.36	9.1	9/16	-904
121HOB _ 9/16-18	9/16-18	0.82	20.8	0.39	9.9	11/16	-906
121HOB _ 3/4-16	3/4-16	0.89	22.6	0.44	11.2	7/8	-908
121HOB _ 1 1/16-12	1 1/16-12	1.12	28.4	0.59	15.0	1 1/4	-912
121HOB _ 1 5/16-12	1 5/16-12	1.18	30.0	0.59	15.0	1 1/2	-916

\* Per SAE J1926 and MS 16142. See page 80 for mounting dimensions.

\*\* O-rings used are Fluorocarbon FKM 90 Durometer. Other O-ring materials are available on request.

"D" Dimension is minimum opening. Dimensions are for reference only, and are subject to change without notice.

**122 H  
HEX NIPPLE**

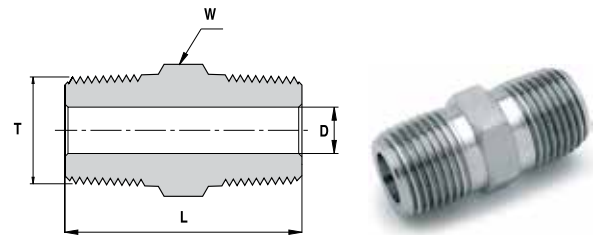

Ordering Information	T Male NPT Size	L		D Min. Opening		W Hex. Flat inch
		inch	mm	inch	mm	
122H _ 1/16	1/16	1.01	25.7	0.12	3.0	5/16
122H _ 1/8	1/8	1.01	25.7	0.19	4.8	7/16
122H _ 1/4	1/4	1.40	35.6	0.28	7.1	9/16
122H _ 3/8	3/8	1.43	36.3	0.38	9.6	11/16
122H _ 1/2	1/2	1.84	46.7	0.47	11.9	7/8
122H _ 3/4	3/4	1.84	46.7	0.62	15.8	1 1/16
122H _ 1	1	2.32	58.9	0.87	22.1	1 3/8

**122 HNR  
HEX NIPPLE NPT TO BSPT**

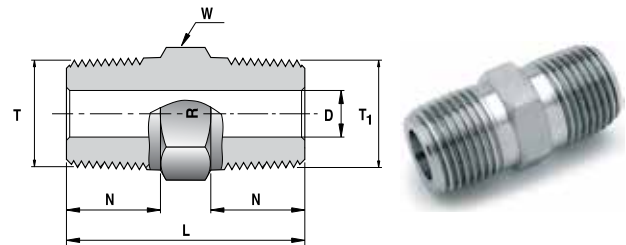

Ordering Information	T Male NPT Size	T1 Male BSPT ISO 7/1, BS21 Size	L		N		D Min. Opening		W Hex. Flat inch
			inch	mm	inch	mm	inch	mm	
122HNR _ 1/8	1/8	1/8-28	1.01	25.6	0.38	9.7	0.19	4.8	7/16
122HNR _ 1/4	1/4	1/4-19	1.40	35.6	0.56	14.2	0.28	7.1	9/16
122HNR _ 3/8	3/8	3/8-19	1.43	36.3	0.56	14.2	0.38	9.6	11/16
122HNR _ 1/2	1/2	1/2-14	1.84	46.7	0.75	19.0	0.47	11.9	7/8
122HNR _ 3/4	3/4	3/4-14	1.84	46.7	0.75	19.0	0.62	15.8	1 1/16
122HNR _ 1	1	1-11	2.32	58.9	0.94	23.9	0.87	22.1	1 3/8

“D” Dimension is minimum opening. Dimensions are for reference only, and are subject to change without notice.

## 122 HNG HEX NIPPLE NPT TO BSPP

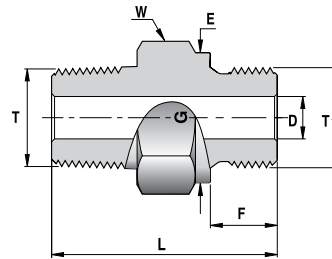

Ordering Information	T Male NPT Size	T1 Male BSPP ISO 228/1, BS 2779	L		F		E		D Min. Opening		W Hex. Flat inch
			inch	mm	inch	mm	inch	mm	inch	mm	
122HNG _ 1/8	1/8	1/8-28	1.07	27.2	0.28	7.1	0.54	13.8	0.16	4.1	9/16
122HNG _ 1/4	1/4	1/4-19	1.44	36.6	0.44	11.2	0.71	18.0	0.23	5.8	3/4
122HNG _ 3/8	3/8	3/8-19	1.47	37.3	0.44	11.2	0.85	21.8	0.31	7.9	7/8
122HNG _ 1/2	1/2	1/2-14	1.78	45.2	0.56	14.2	1.02	26.0	0.47	11.9	1 1/16
122HNG _ 3/4	3/4	3/4-14	1.95	49.5	0.62	15.7	1.26	32.0	0.62	15.8	1 5/16
122HNG _ 1	1	1-11	2.26	57.4	0.72	18.3	1.53	39.0	0.78	19.8	1 5/8

For Parallel Threads Sealing, see page 76

## 122HNOB HEX NIPPLE NPT TO SAE/MS STRAIGHT THREAD BOSS \*

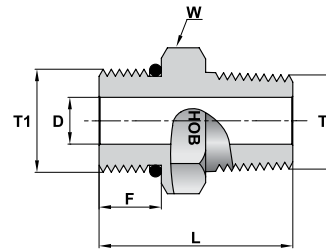

Ordering Information	T Male NPT Size	T1 Straight Thread UN	D		L		F		W Hex. Flat inch	O-Ring**
			inch	mm	inch	mm	inch	mm		
122HNOB _ 1/4 X 7/16-20	1/4	7/16-20	0.20	5.1	1.20	30.5	0.36	9.1	9/16	-904
122HNOB _ 3/8 X 9/16-18	3/8	9/16-18	0.28	7.1	1.26	32.0	0.39	9.9	11/16	-906
122HNOB _ 1/2 X 3/4-16	1/2	3/4-16	0.42	10.7	1.53	38.9	0.44	11.2	7/8	-908
122HNOB _ 3/4 X 1 1/16-12	3/4	1 1/16-12	0.62	15.7	1.75	44.4	0.59	15.0	1 1/4	-912
122HNOB _ 1 X 1 5/16-12	1	1 5/16-12	0.88	22.4	2.00	50.8	0.59	15.0	1 1/2	-916

## 122HCN CLOSE NIPPLE

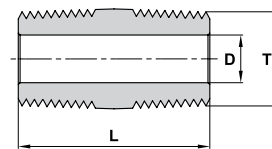

Ordering Information	T Male NPT Size	D		L	
		inch	mm	inch	mm
122HCN _ 1/8	1/8	0.19	4.8	0.75	19.1
122HCN _ 1/4	1/4	0.28	7.1	1.12	28.4
122HCN _ 3/8	3/8	0.38	9.6	1.12	28.4
122HCN _ 1/2	1/2	0.47	11.9	1.50	38.1
122HCN _ 3/4	3/4	0.62	15.7	1.50	38.1
122HCN _ 1	1	0.88	22.4	1.88	47.8

\* Per SAE J1926 and MS 16142. See page 80 for mounting dimensions.

\*\* O-rings used are Fluorocarbon FKM 90 Durometer. Other O-ring materials are available on request.

"D" Dimension is minimum opening. Dimensions are for reference only, and are subject to change without notice.

**123 H**  
**REDUCING NIPPLE**

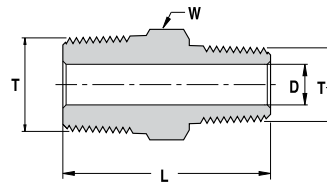

Ordering Information	T Male NPT Size	T1 Male NPT Size	L		D Min. Opening		W Hex. Flat inch
			inch	mm	inch	mm	
123H _ 1/8 X 1/16	1/8	1/16	1.01	25.7	0.12	3.0	7/16
123H _ 1/4 X 1/8	1/4	1/8	1.22	31.0	0.19	4.8	9/16
123H _ 3/8 X 1/8	3/8	1/8	1.25	31.8	0.19	4.8	11/16
123H _ 3/8 X 1/4	3/8	1/4	1.43	36.3	0.28	7.1	11/16
123H _ 1/2 X 1/8	1/2	1/8	1.47	37.3	0.19	4.8	7/8
123H _ 1/2 X 1/4	1/2	1/4	1.65	41.9	0.28	7.1	7/8
123H _ 1/2 X 3/8	1/2	3/8	1.65	41.9	0.38	9.6	7/8
123H _ 3/4 X 1/4	3/4	1/4	1.65	41.9	0.28	7.1	1 1/16
123H _ 3/4 X 1/2	3/4	1/2	1.84	46.7	0.47	11.9	1 1/16
123H _ 1 X 1/2	1	1/2	2.13	54.1	0.47	11.9	1 3/8
123H _ 1 X 3/4	1	3/4	2.13	54.1	0.62	15.8	1 3/8

**3600 H**  
**BRANCH TEE**

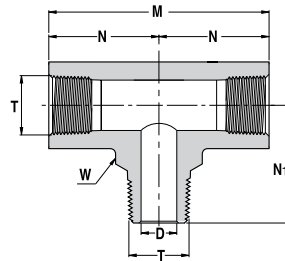

Ordering Information	T Male & Female NPT	M		N		N1		D		W Wrench Flat inch
		inch	mm	inch	mm	inch	mm	inch	mm	
3600H _ 1/8	1/8	2.08	52.8	1.04	26.4	0.87	22.1	0.19	4.8	5/8
3600H _ 1/4	1/4	2.34	59.4	1.17	29.7	1.17	29.7	0.28	7.1	13/16
3600H _ 3/8	3/8	2.84	72.1	1.42	36.1	1.26	32.0	0.38	9.6	15/16
3600H _ 1/2	1/2	3.12	79.2	1.56	39.6	1.56	39.6	0.47	11.9	1 1/8

“D” Dimension is minimum opening. Dimensions are for reference only, and are subject to change without notice.

### 3750 H STREET TEE

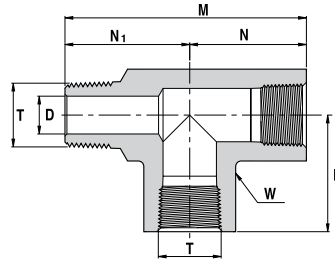

Ordering Information	T Male & Female NPT	M		N		N1		D Min. Opening		W Wrench Flat
		inch	mm	inch	mm	inch	mm	inch	mm	inch
3750H _ 1/8	1/8	1.91	48.5	1.04	26.4	0.87	22.1	0.19	4.8	5/8
3750H _ 1/4	1/4	2.34	59.4	1.17	29.7	1.17	29.7	0.28	7.1	13/16
3750H _ 3/8	3/8	2.68	68.1	1.42	36.1	1.26	32.0	0.38	9.6	15/16
3750H _ 1/2	1/2	3.12	79.2	1.56	39.6	1.56	39.6	0.47	11.9	1 1/8

### 130 HM MALE TO HOSE CONNECTOR

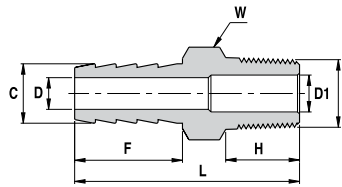

Ordering Information	Hose I.D.	T Male NPT Size	C		D		D1		F		H		L		W Hex. Flat
			inch	mm	inch	mm	inch	mm	inch	mm	inch	mm	inch	mm	inch
130HM _ 1/8 X 1/8	1/8	1/8	0.15	3.80	0.08	2.0	0.19	4.80	0.40	10.2	0.38	9.70	1.08	27.4	7/16
130HM _ 1/8 X 1/4	1/8	1/4	0.15	3.80	0.08	2.0	0.28	7.10	0.40	10.2	0.56	14.2	1.26	32.0	9/16
130HM _ 3/16 X 1/8	3/16	1/8	0.23	5.84	0.12	3.0	0.12	3.00	0.59	15.0	0.38	9.70	1.27	32.3	7/16
130HM _ 3/16 X 1/4	3/16	1/4	0.23	5.84	0.12	3.0	0.28	7.10	0.59	15.0	0.56	14.2	1.45	36.8	9/16
130HM _ 1/4 X 1/8	1/4	1/8	0.30	7.62	0.19	4.8	0.19	4.80	0.79	20.1	0.38	9.70	1.47	37.3	7/16
130HM _ 1/4 X 1/4	1/4	1/4	0.30	7.62	0.19	4.8	0.19	4.80	0.79	20.1	0.56	14.2	1.65	41.9	9/16
130HM _ 1/4 X 3/8	1/4	3/8	0.30	7.62	0.19	4.8	0.19	4.80	0.79	20.1	0.56	14.2	1.66	42.2	11/16
130HM _ 1/4 X 1/2	1/4	1/2	0.30	7.62	0.19	4.8	0.47	11.9	0.79	20.1	0.75	19.0	1.85	47.0	7/8
130HM _ 5/16 X 1/8	5/16	1/8	0.38	9.65	0.19	4.8	0.19	4.80	0.87	22.1	0.38	9.70	1.55	39.4	7/16
130HM _ 5/16 X 1/4	5/16	1/4	0.38	9.65	0.19	4.8	0.19	4.80	0.87	22.1	0.56	14.2	1.73	43.9	9/16
130HM _ 5/16 X 3/8	5/16	3/8	0.38	9.65	0.19	4.8	0.37	9.50	0.87	22.1	0.56	14.2	1.74	44.2	11/16
130HM _ 5/16 X 1/2	5/16	1/2	0.38	9.65	0.19	4.8	0.47	11.9	0.87	22.1	0.75	19.0	1.96	49.8	7/8
130HM _ 3/8 X 1/4	3/8	1/4	0.45	11.43	0.30	7.6	0.30	7.60	0.87	22.1	0.56	14.2	1.73	43.9	9/16
130HM _ 3/8 X 3/8	3/8	3/8	0.45	11.43	0.30	7.6	0.30	7.60	0.87	22.1	0.56	14.2	1.74	44.2	11/16
130HM _ 3/8 X 1/2	3/8	1/2	0.45	11.43	0.30	7.6	0.30	7.60	0.87	22.1	0.75	19.0	1.96	49.8	7/8
130HM _ 1/2 X 1/4	1/2	1/4	0.60	15.24	0.37	9.5	0.28	7.10	0.94	23.8	0.56	14.2	1.80	45.7	11/16
130HM _ 1/2 X 3/8	1/2	3/8	0.60	15.24	0.37	9.5	0.37	9.50	0.94	23.8	0.56	14.2	1.81	46.0	11/16
130HM _ 1/2 X 1/2	1/2	1/2	0.60	15.24	0.37	9.5	0.37	9.50	0.94	23.8	0.75	19.0	2.03	51.6	7/8
130HM _ 5/8 X 1/2	5/8	1/2	0.75	19.10	0.47	11.9	0.47	11.9	0.98	24.9	0.75	19.0	2.07	52.6	1 1/16
130HM _ 5/8 X 3/4	5/8	3/4	0.75	19.10	0.50	12.7	0.63	16.0	0.98	24.9	0.75	19.0	2.07	52.6	1 1/16
130HM _ 3/4 X 1/2	3/4	1/2	0.90	22.86	0.63	16.0	0.47	11.9	1.05	26.7	0.75	19.0	2.14	54.4	1 1/16
130HM _ 3/4 X 3/4	3/4	3/4	0.90	22.86	0.63	16.0	0.63	16.0	1.05	26.7	0.75	19.0	2.14	54.4	1 1/16
130HM _ 3/4 X 1	3/4	1	0.90	22.86	0.63	16.0	0.88	22.4	1.05	26.7	0.94	23.9	2.43	61.7	1 3/8
130HM _ 1 X 3/4	1	3/4	1.2	30.48	0.88	22.4	0.63	16.0	1.19	30.2	0.75	19.0	2.38	60.5	1 3/8
130HM _ 1 X 1	1	1	1.2	30.48	0.88	22.4	0.88	22.4	1.19	30.2	0.94	23.9	2.57	65.3	1 3/8

"D" Dimension is minimum opening. Dimensions are for reference only, and are subject to change without notice.



**130 HF  
FEMALE HOSE  
CONNECTOR**

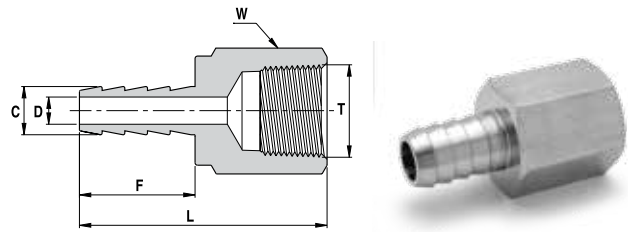

Ordering Information	Hose I.D.	T NPT Size	C		D		F		L		W Hex. Flat
			inch	mm	inch	mm	inch	mm	inch	mm	
130HF_ 1/8 X 1/8	1/8	1/8	0.15	3.80	0.08	2.00	0.40	10.2	1.11	28.2	9/16
130HF_ 1/8 X 1/4	1/8	1/4	0.15	3.80	0.08	2.00	0.40	10.2	1.26	32.0	3/4
130HF_ 3/16 X 1/8	3/16	1/8	0.23	5.84	0.12	3.00	0.59	15.0	1.29	32.8	9/16
130HF_ 3/16 X 1/4	3/16	1/4	0.23	5.84	0.12	3.00	0.59	15.0	1.44	36.6	3/4
130HF_ 1/4 X 1/8	1/4	1/8	0.30	7.62	0.19	4.80	0.79	20.1	1.47	37.3	9/16
130HF_ 1/4 X 1/4	1/4	1/4	0.30	7.62	0.19	4.80	0.79	20.1	1.64	41.7	3/4
130HF_ 1/4 X 3/8	1/4	3/8	0.30	7.62	0.19	4.80	0.79	20.1	1.71	43.4	7/8
130HF_ 5/16 X 1/4	5/16	1/4	0.38	9.65	0.19	4.80	0.87	22.1	1.73	43.9	3/4
130HF_ 5/16 X 3/8	5/16	3/8	0.38	9.65	0.19	4.80	0.87	22.1	1.82	46.2	7/8
130HF_ 3/8 X 1/4	3/8	1/4	0.45	11.43	0.30	7.60	0.87	22.1	1.69	42.9	3/4
130HF_ 3/8 X 3/8	3/8	3/8	0.45	11.43	0.30	7.60	0.87	22.1	1.78	45.2	7/8
130HF_ 3/8 X 1/2	3/8	1/2	0.45	11.43	0.30	7.60	0.87	22.1	2.03	51.6	1 1/16
130HF_ 1/2 X 1/2	1/2	1/2	0.60	15.24	0.38	9.70	0.94	23.9	2.13	54.1	1 1/16

**130 LT  
TUBE TO  
HOSE CONNECTOR**

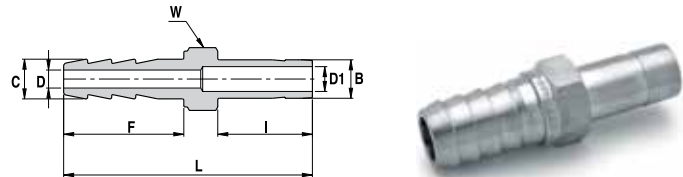

Ordering Information	Hose I.D.	B Tube Size	C		D		D1		F		I		L		W Hex. Flat
			inch	mm	inch	mm	inch	mm	inch	mm	inch	mm	inch	mm	
130LT_ 1/8 X 1/8	1/8	1/8	0.15	3.80	0.08	2.00	0.08	2.00	0.40	10.2	0.53	13.5	1.35	34.3	5/16
130LT_ 1/8 X 1/4	1/8	1/4	0.15	3.80	0.08	2.00	0.17	4.20	0.40	10.2	0.62	15.7	1.44	36.6	3/8
130LT_ 1/4 X 1/4	1/4	1/4	0.30	7.62	0.19	4.80	0.17	4.20	0.79	20.1	0.62	15.7	1.83	46.5	7/16
130LT_ 1/4 X 3/8	1/4	3/8	0.30	7.62	0.19	4.80	0.27	6.85	0.79	20.1	0.69	17.5	1.90	48.3	7/16
130LT_ 1/4 X 6 MM	1/4	6mm	0.30	7.62	0.19	4.80	0.16	4.00	0.79	20.1	0.62	15.7	1.86	47.2	7/16
130LT_ 5/16 X 1/4	5/16	1/4	0.37	9.40	0.19	4.80	0.17	4.20	0.87	22.1	0.62	15.7	1.91	48.5	7/16
130LT_ 3/8 X 3/8	3/8	3/8	0.45	11.43	0.30	7.60	0.27	6.85	0.87	22.1	0.69	17.5	1.98	50.3	9/16
130LT_ 3/8 X 1/2	3/8	1/2	0.45	11.43	0.30	7.60	0.37	9.40	0.87	22.1	0.91	23.1	2.20	55.9	5/8
130LT_ 1/2 X 3/8	1/2	3/8	0.60	15.24	0.38	9.70	0.27	6.85	0.94	23.9	0.69	17.5	2.05	52.1	11/16
130LT_ 1/2 X 1/2	1/2	1/2	0.60	15.24	0.38	9.70	0.37	9.40	0.94	23.9	0.91	23.1	2.27	57.7	11/16
130LT_ 3/4 X 3/4	3/4	3/4	0.90	22.86	0.63	16.0	0.59	15.0	1.05	26.7	0.97	24.6	2.44	62.0	1 1/16

"D" Dimension is minimum opening. Dimensions are for reference only, and are subject to change without notice.

